

# VANO UTILITY 900 L x 200 H x 100 P

## DIMENSIONI DISPONIBILI:

300Lx100Hx100P mm.      300Lx200Hx100P mm.  
 600Lx100Hx100P mm.      600Lx200Hx100P mm.  
 900Lx100Hx100P mm.      900Lx200Hx100P mm.

300Lx100Hx200P mm.      300Lx200Hx200P mm.  
 600Lx100Hx200P mm.      600Lx200Hx200P mm.  
 900Lx100Hx200P mm.      900Lx200Hx200P mm.

300Lx100Hx300P mm.      300Lx200Hx300P mm.  
 600Lx100Hx300P mm.      600Lx200Hx300P mm.  
 900Lx100Hx300P mm.      900Lx200Hx300P mm.

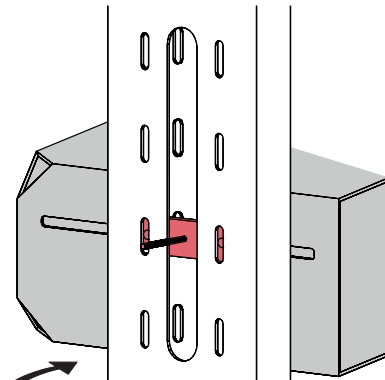
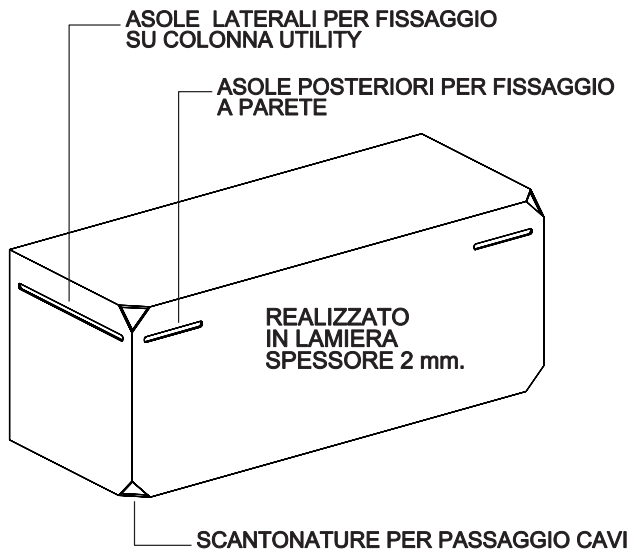
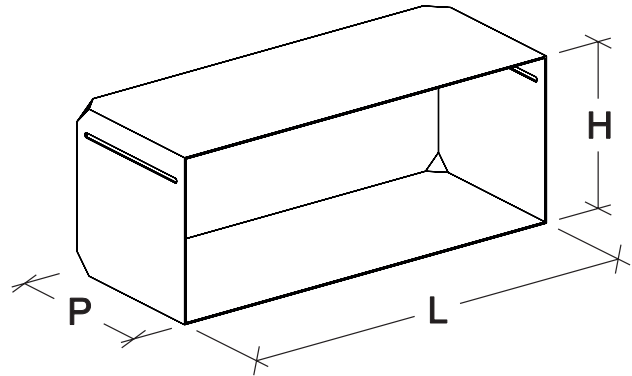

UNA VOLTA FISSATO IL VANO LAMINA SVITARE PERNO DI AUSILIO MONTAGGIO

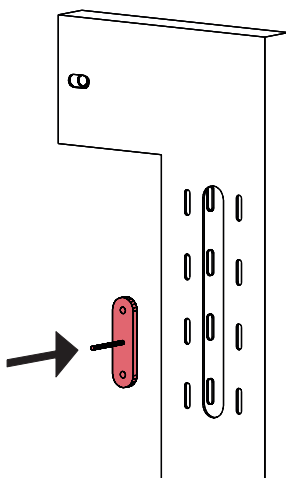

INSERIRE PIASTRINO AL INTERNO DELLA COLONNA UTILITY

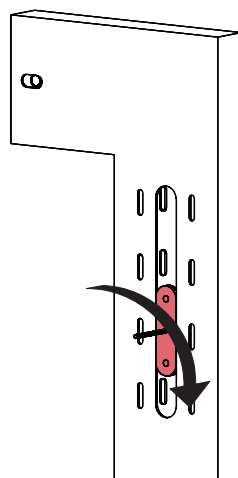

RUOTARE PIASTRINO E FARE CORRISPONDERE FORI FILETTATI CON LE ASOLE DELLA COLONNA UTILITY

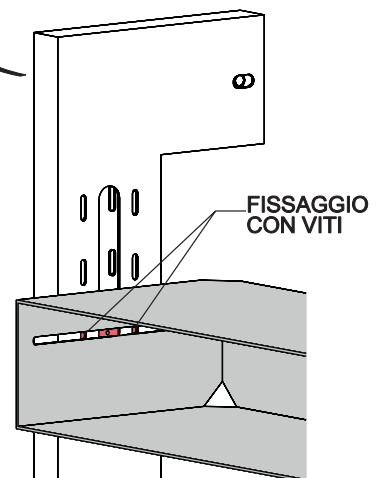

DALLA PARTE OPPOSTA DELLA COLONNA UTILITY FISSARE TRAMITE VITI IL VANO LAMINA