

# VANO UTILITY 600 L x 200 H x 100 P

## DIMENSIONI DISPONIBILI:

300Lx100Hx100P mm.      300Lx200Hx100P mm.  
 600Lx100Hx100P mm.      600Lx200Hx100P mm.  
 900Lx100Hx100P mm.      900Lx200Hx100P mm.

300Lx100Hx200P mm.      300Lx200Hx200P mm.  
 600Lx100Hx200P mm.      600Lx200Hx200P mm.  
 900Lx100Hx200P mm.      900Lx200Hx200P mm.

300Lx100Hx300P mm.      300Lx200Hx300P mm.  
 600Lx100Hx300P mm.      600Lx200Hx300P mm.  
 900Lx100Hx300P mm.      900Lx200Hx300P mm.

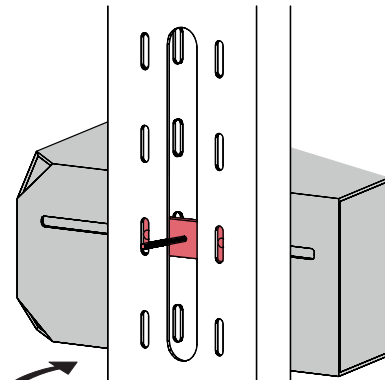
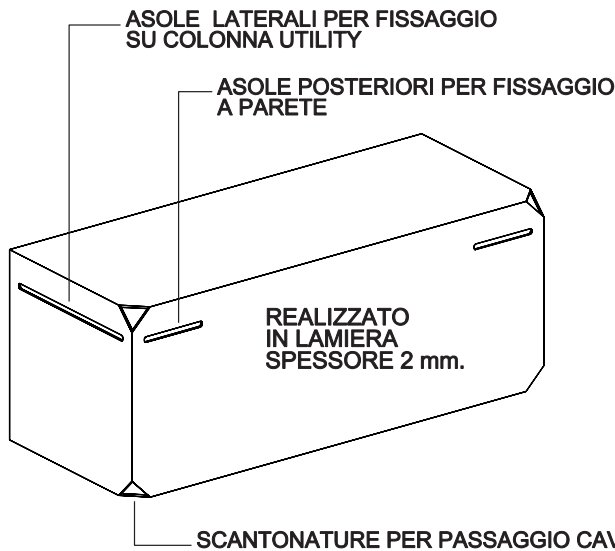
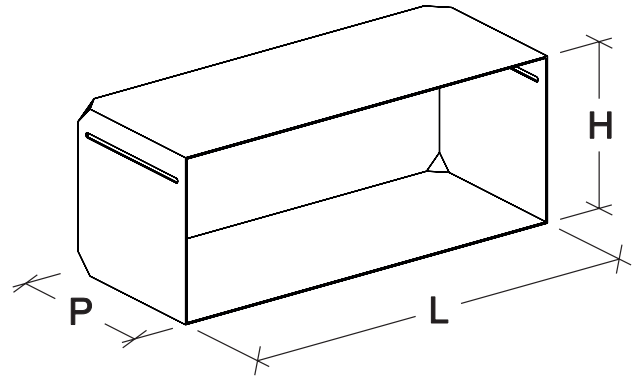

UNA VOLTA FISSATO  
IL VANO LAMINA SVITARE  
PERNO DI AUSILIO MONTAGGIO

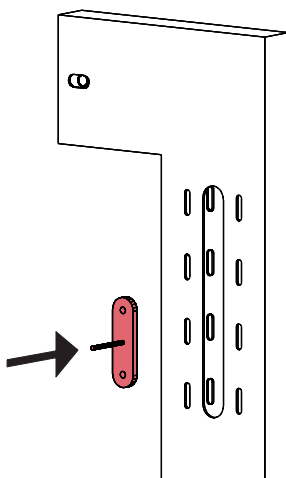

INSERIRE PIASTRINO  
AL INTERNO DELLA  
COLONNA UTILITY

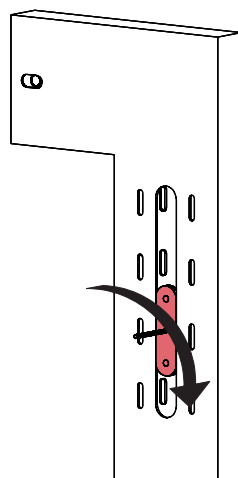

RUOTARE PIASTRINO E  
FARE CORRISPONDERE  
FORI FILETTATI CON LE ASOLE  
DELLA COLONNA UTILITY

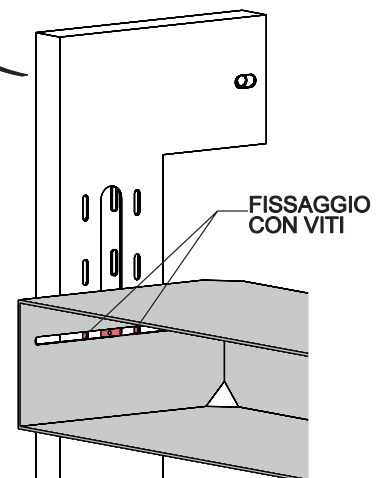

DALLA PARTE OPPOSTA  
DELLA COLONNA UTILITY  
FISSARE TRAMITE VITI  
IL VANO LAMINA