

UTILITY RIPIANO IN METALLO 540

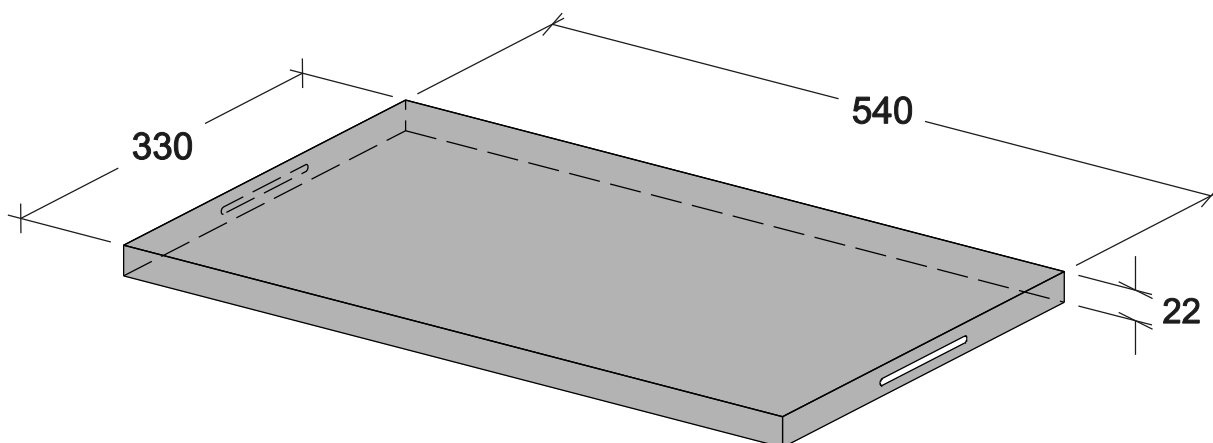

ESEMPIO SISTEMA DI FISSAGGIO SU MONTANTI UTILITY

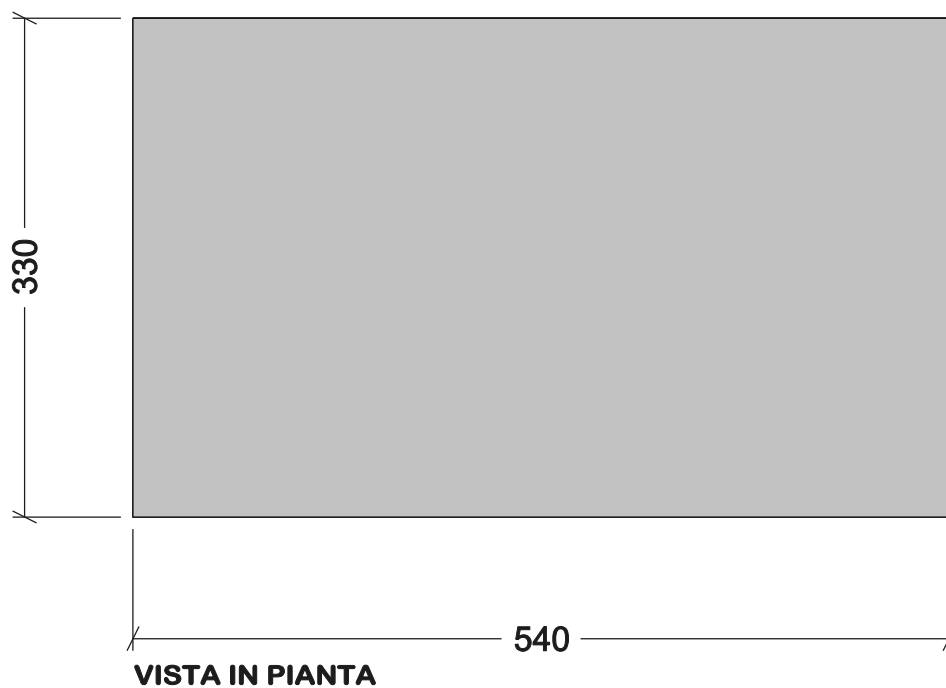