

GAMBA PENISOLA 02

PROSPETTO FRONTALE

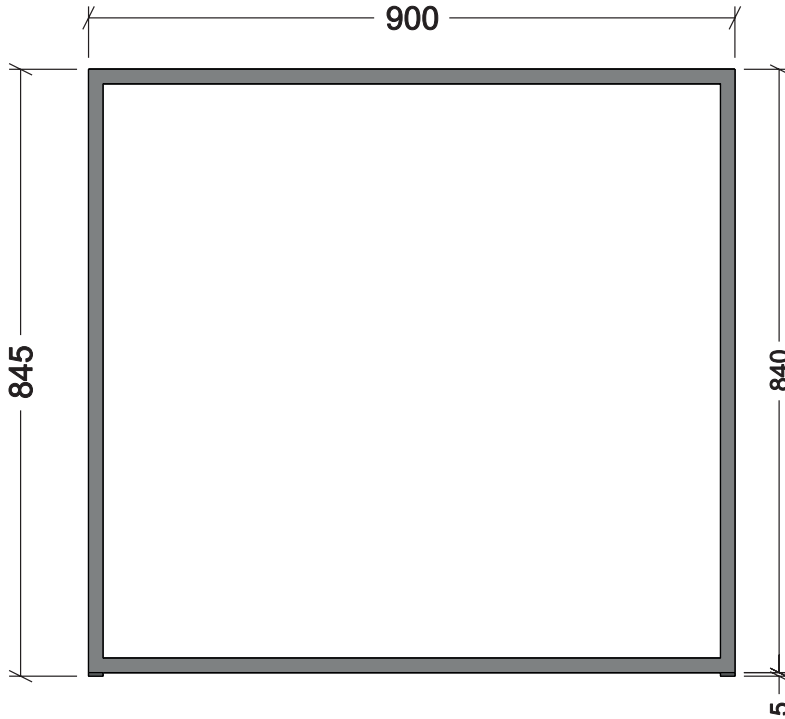

SISTEMA DI FISSAGGIO AL PIANO DELLA PENISOLA

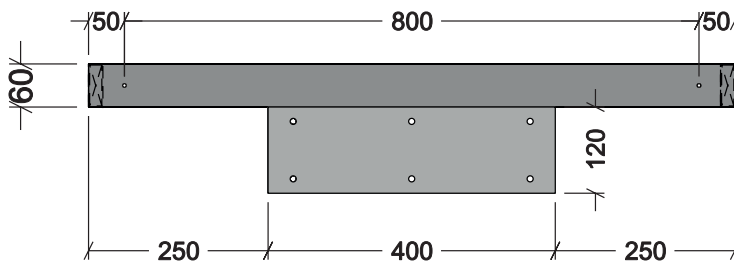
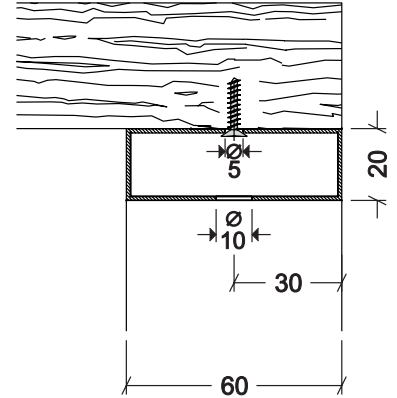

VISTA IN PIANTA

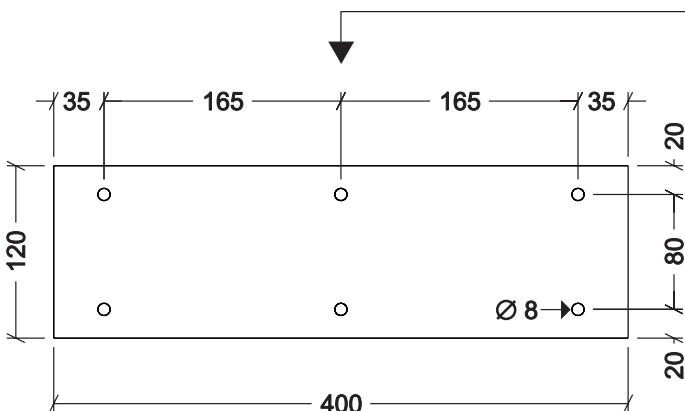

PIASTRA SPESSORE 3 mm.
SALDATA FILO SUPERIORE
DELLA GAMBA

REALIZZATA CON TUBOLARE DIM. 60x20 mm.

